

Edge Series Wall Consoles

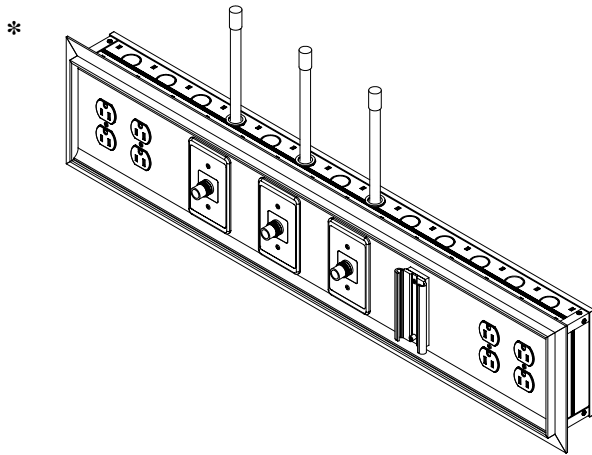

* 13 gangs Edge Series Wall Console

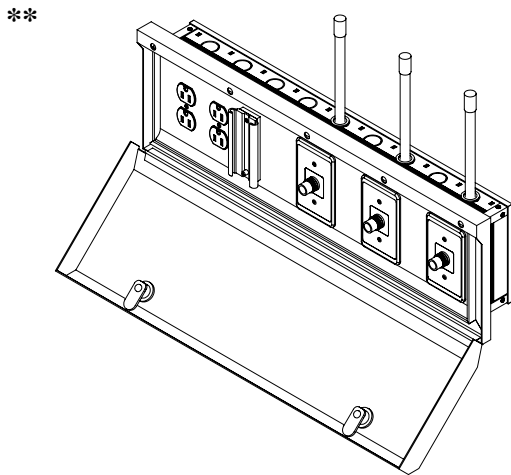

** 9 gangs Edge Series Security Wall Console

Item number definition

SWC / WC-XX00-NF

"XX"= Number of gangs

NF= Non-Ferrous

Available Length:

5 to 21 gangs (15" to 53")

Construction Specification

This Wall Console shall have a unique fascia for the entire services strip. Back box and finishing frame shall be a one piece design, which will accommodate different components for each of the services. Frame and side of the box are made of heavy gauge extruded aluminium.

The back plate shall be made of 18 gauges galvanized steel. Top and bottom of the box shall be pre-punched for electrical and mechanical connections to devices.

The front fascia shall be having opening every 2.375" center to center to permit access to the different services and blank space.

The unit is also available with a lockable stainless steel security front cover.

This product is cULus listed.

*** Only the regular model is available with non-ferrous components.

Medical Gas

Medical gas outlets shall be supplied and installed by Medical Design. All outlets to be manifolded on site by local contractor. Installation and testing shall comply with National Fire Protection Association (NFPA 99c) & C.R.N. (BNQ 5710-500, CSA 305.1 / B51-95).

Electrical Equipment

Electrical devices shall be supplied and installed by Medical Design. All electrical receptacles are NEMA 5-15/20R, 125 volts AC, hospital grade and comply with CSA and are cULus listed.

All components, installation, and testing shall comply with NFPA and National Electrical Code (NEC).

Receptacles shall be red for emergency and ivory for normal power.

Communication

Communication devices shall be supplied and installed by others. Provisions for devices shall be coordinated with Medical Design.

Site Installation

All units shall be installed in accordance with Medical Design's installation instructions. The mechanical and electrical contractor shall provide the final connection to the Hospital System. The contractor has the responsibility to insure that every unit is subject to a final site inspection in compliance with all National, State and Local Codes.

Typical Shop Drawing



EDGE SERIES WALL CONSOLE / SECURITY WALL CONSOLE

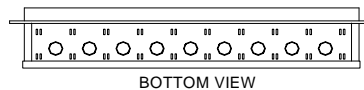
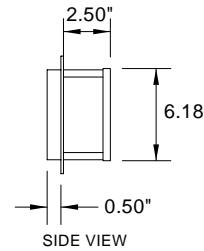
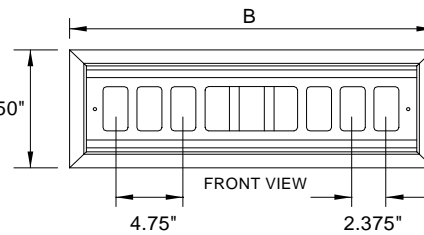
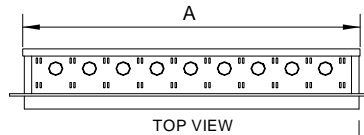
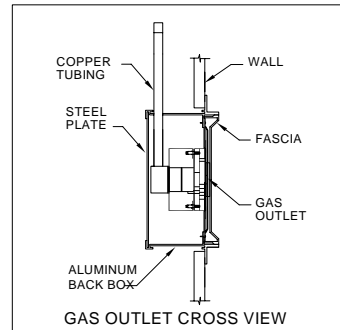
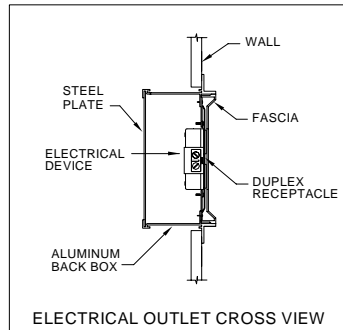
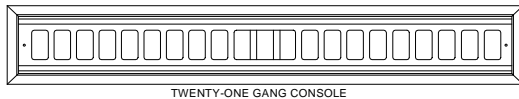
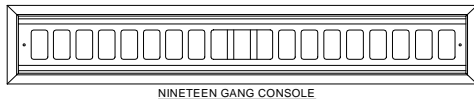
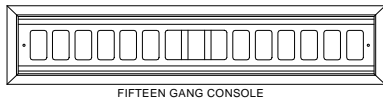
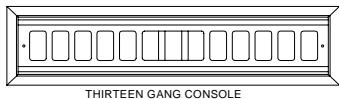
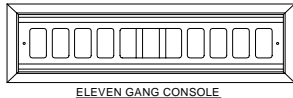
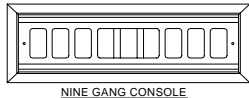
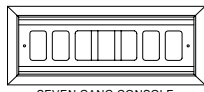
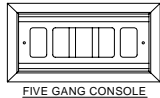

No. OF GANGS		5	7	9	11	13	15	17	19	21
WALL OPENING	A	13.800"	18.550"	23.300"	28.050"	32.800"	37.550"	42.300"	47.050"	51.800"
FRAME OVERALL LENGHT	B	15.125"	19.875"	24.625"	29.375"	34.125"	38.875"	43.625"	48.375"	53.125"

LEGEND

MEDICAL GAS		
ID	QTY	DESCRIPTION
O ₂	-	OXYGEN OUTLET ; Q.C. <input type="checkbox"/> OU D.I.S.S. <input type="checkbox"/>
A	-	MEDICAL AIR OUTLET ; Q.C. <input type="checkbox"/> OU D.I.S.S. <input type="checkbox"/>
V	-	VACUUM OUTLET ; Q.C. <input type="checkbox"/> OU D.I.S.S. <input type="checkbox"/>
N ₂	-	NITROGEN OUTLET ; D.I.S.S. ONLY <input type="checkbox"/>
N ₂ O	-	NITROUS OXIDE OUTLET ; Q.C. <input type="checkbox"/> OU D.I.S.S. <input type="checkbox"/>
EVAC	-	EVACUATION OUTLET ; Q.C. <input type="checkbox"/> OU D.I.S.S. <input type="checkbox"/>
CO ₂	-	CARBON DIOXIDE OUTLET ; D.I.S.S. ONLY <input type="checkbox"/>

ELECTRICITY AND COMMUNICATION		
DR	-	DUPLEX RECEPTACLE, 20A, 125V, H.G., (RED) EMERGENCY POWER (HUBBELL #8300HR)
DW	-	DUPLEX RECEPTACLE, 20A, 125V, H.G., (WHITE) NORMAL POWER (HUBBELL #8300HW)
SR	-	SIMPLEX RECEPTACLE, 20A, 125V, H.G., (RED) EMERGENCY POWER (HUBBELL #8310R)
SW	-	SIMPLEX RECEPTACLE, 20A, 125V, H.G., (WHITE) NORMAL POWER (HUBBELL #8310W)
NC	-	NURSE CALL PROVISION, 3 GANGS
D	-	DATA PROVISION, 1 GANG
T	-	TELEPHONE PROVISION, 1GANG
B	-	BLANK FACEPLATE, 1 GANG, STAINLESS STEEL

ACCESSORIES		
SL	-	VACUUM BOTTLE SLIDE

OTHER SERVICES AND ACCESSORIES ARE AVAILABLE. CONTACT US FOR MORE INFORMATION.

SECURITY MODEL

DOOR OPENING AT 180° DOWNWARD

